

fret farm

The Incomplete, Slightly Diluted, but Extremely Useful

LEFT-HANDED 5 STRING BASS

Reference

A Sample of The Complete Version

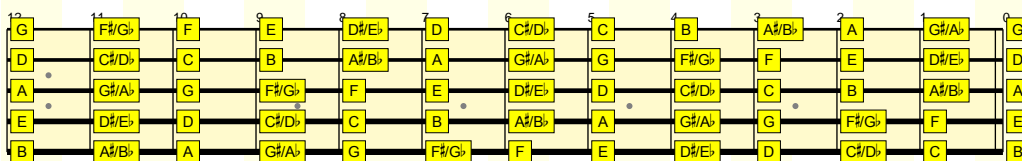



INFO

The book, its contents, and its layout and design are Copyright (c) 2003-2005 Fret Farm Productions. All rights are reserved. In particular, you may not copy or distribute this book, in any form, electronic or physical, save for making print-outs for your personal and sole use.

You have purchased the right to print this electronic book for your own personal use: not to make copies for all your friends.

Please respect the effort that went into creating the book, and stump up the very modest cover price for your own copy (or buy your mates a copy each). We've worked hard to make sure it is as useful as it can possibly be, and further editions will only be secure if you support it with your purchases.

For more information about how to use these charts, including tutorials on chord voicing, scale playing and writing songs, visit the fret farm at www.fretfarm.com.

MESSAGE FROM THE VET

This book was born on the fret farm on Friday September 09, 2005. It is a healthy version 4 delivery, with all its charts and diagrams in place.

SAMPLE VERSION

Thank you for downloading this book. We think you'll agree that it is the clearest reference for chords, scales and songwriting available.

This book contains only a sample of the information in the complete book. Your performance and song-writing would benefit immensely from getting hold of the full book, allowing you to write and play in any key.

You can buy the complete reference at www.fretfarm.com.

INTRO

This book contains a complete reference to playing a standard-tuned 5 string bass.

It contains detailed key-by-key information, an exhaustive library of chords, and comprehensive scales for soloing. The book is intended as a quick reference for a wide range of players. It can be used to help learn chords, to practice soloing, or to write complete songs.

CHORD AND SCALE DIAGRAMS

Most of the chord and scale diagrams in this book are shown as a full fretboard, with all notes marked. For example, the chord of A major looks like:

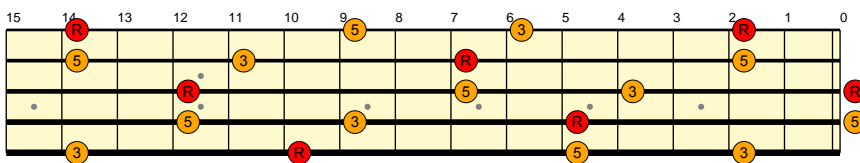

The different notes in the scale or chord are marked with different symbols. The root note is marked in red, with the R symbol, for example.

To play a bass part under a chord, you can play any of these notes, and it will be guaranteed to work. Alternatively you can play a bass chord by selecting one note of each kind.

Some scales and chords are also shown on a piano keyboard, for those occasions where you really need to show the pianist what to do:

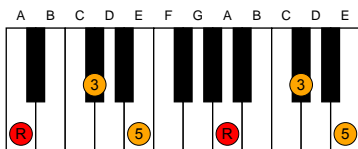

BITS OF THE BOOK

The book is arranged in four parts.

The Key Reference consists of twelve double-page spreads, one for each major key. It is designed to be a one-stop shop for playing in any key, giving a chord reference for each chord, scales and important scale variations, and songwriting aids.

The Chord Reference is a catalog of the most important chords for each of the twelve root notes. If you need to find an unusual or exotic chord, you'll find it here.

O
R
F
E
T

3

The Scale Reference is just like the Chord Reference, but gives complete scales. It contains a wide range of unusual scales that can be used to give original solos.

The final section of the book has a series of useful summary charts. There is a quick-glance voicing chart and a table showing the scales that work over different chords.

THE KEY REFERENCE

The key reference is designed to give you all the information you need to play in one key. There are copies of the reference for each root note.

On the left hand page are the major and minor scale references. There are also chord references for each of the chords in the key.

On the right are a set of more exotic scales for the same root, including pentatonic and different minor scales.

Underneath the scales is a chord map. This is designed to help you write songs in the key, or improvise for a while. The top half of the chord map shows the six chords in the major key. The arrows show which chords naturally flow from one another. Start at the red root chord, then jump anywhere else in the map. Finally follow the arrows back to the red root chord. Arrows with a filled arrowhead are more common transitions.

Under each chord, the map tells you which other keys the chord can be found in. You can use this to change key, simply look up the new key and pick up the chord in that chord map.

The bottom part of the chord contains the relative minor or major chord for each of the six. Following the downwards arrows gives an unusual effect to the song, but it also makes it harder to get back to the root note. Normally you'd do this only when you want to change key.

The final part of the key reference gives you another way of changing keys. It gives you a simple sounding chord progression to take you from one key to another. The smoothest modulations between all sets of keys are given. Some combinations of keys can't be reached directly without major to minor chord changes. For each of these the chart also suggests intermediate keys you can pass through if you don't like the sound of major to minor transitions.

FINDING OUT MORE

There are lots of things you can do with the charts in this book. The fretfarm website (www.fretfarm.com) has a whole set of different tutorials that show you how to get the most out of the chord diagrams, song writing charts, modulations and capo references.

ABOUT THE BOOK

Fret farm was originally created because no chord reference or scale book was available with the right information. Created for our own use, it proved so popular, we decided to make it public.

We create the books with the help of a custom-written software suite. The software understands the structure of music and the structure of your instrument. By changing the specification of the instrument, the software will automatically adjust chord diagrams, scales and voicings.

We then prepare the book from these diagrams, doing the layout and compositing. At each stage clarity is the most important concern: getting all the information you need on one spread, understandable at a glance (once you know what you're looking at, of course).

O
R
F
E
T

5

A

3 sharps

A major, F# minor, A ionian
 B dorian, C# or Db phrygian, D lydian
 E mixolydian, F# or Gb aeolian, G# or Ab locrian

BASIC SCALES

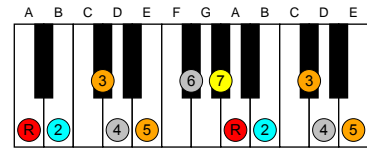
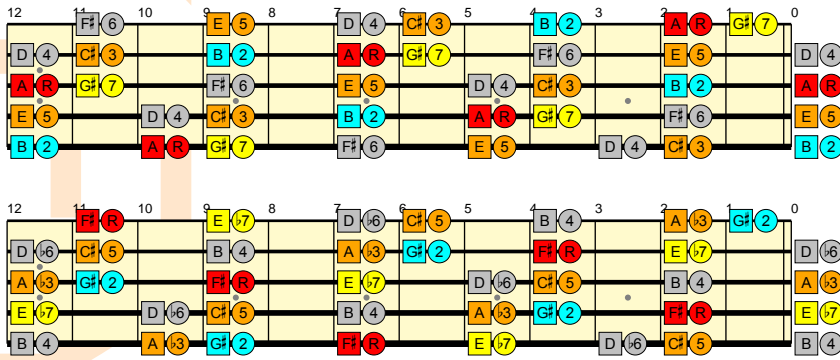

major

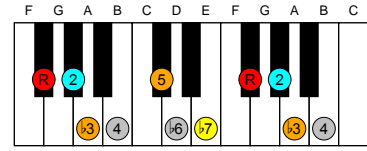

F# minor

CHORDS

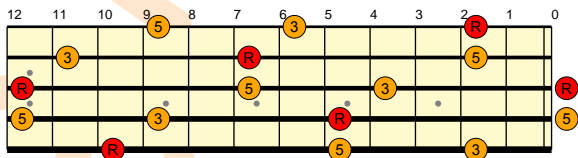

A

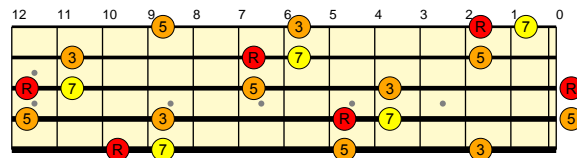

AM7

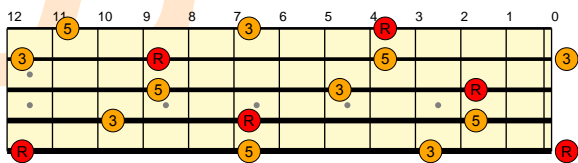

Bm

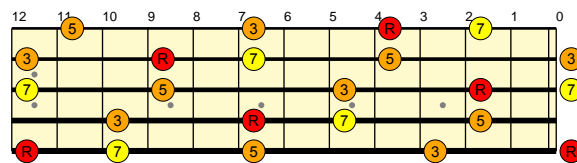

Bm7

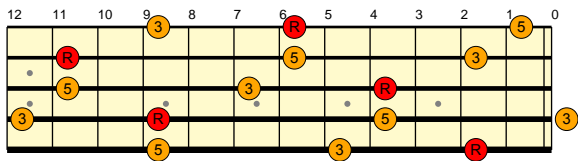

C#m

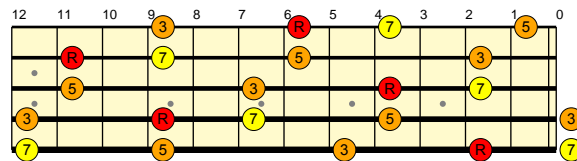

C#m7

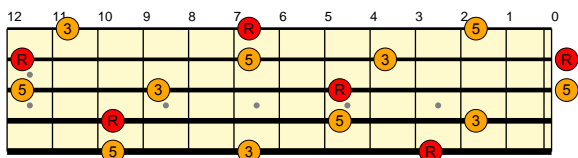

D

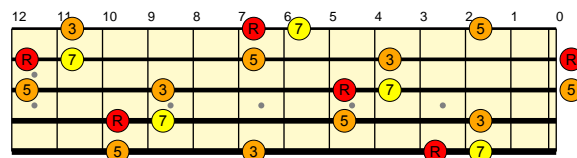

DM7

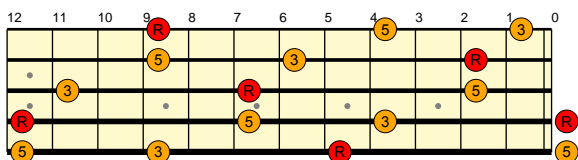

E

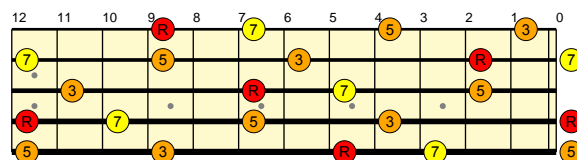

E7

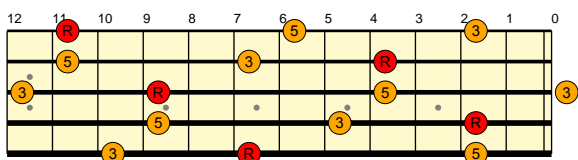

F#m

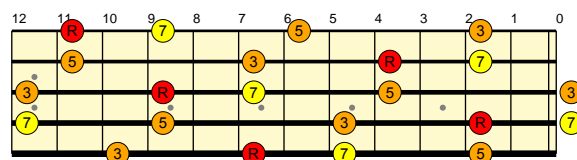

F#m7

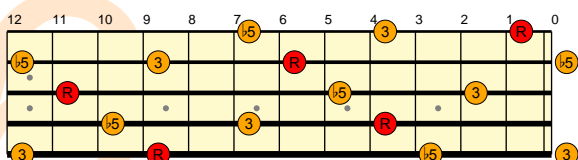

G#dim

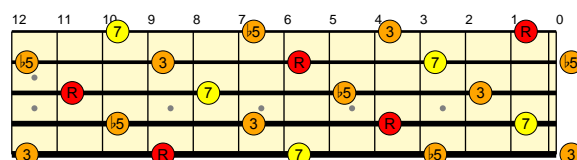

G#dim7

SOLOING SCALES

M blues

blues

pentatonic

m. minor

CHORD PROGRESSIONS

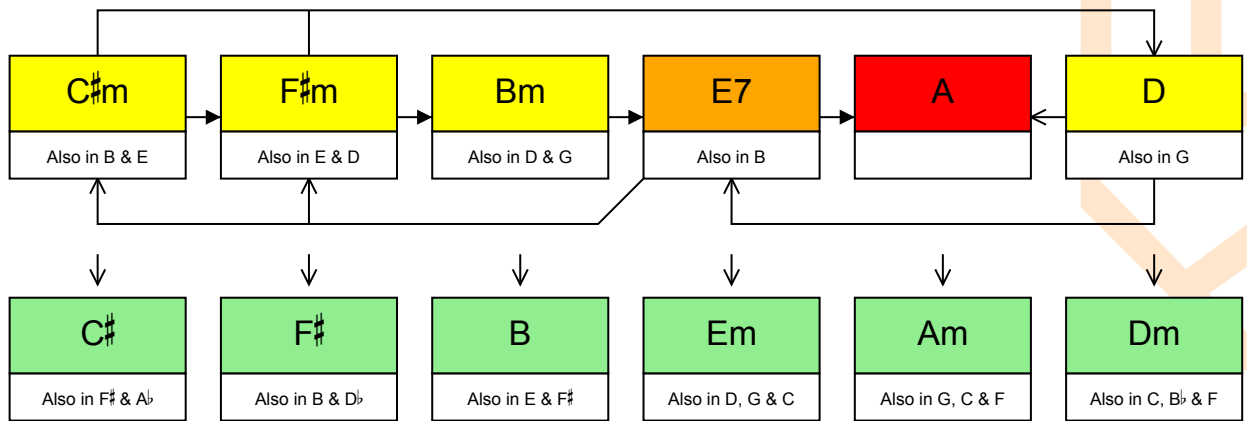

CHANGING TO OTHER KEYS

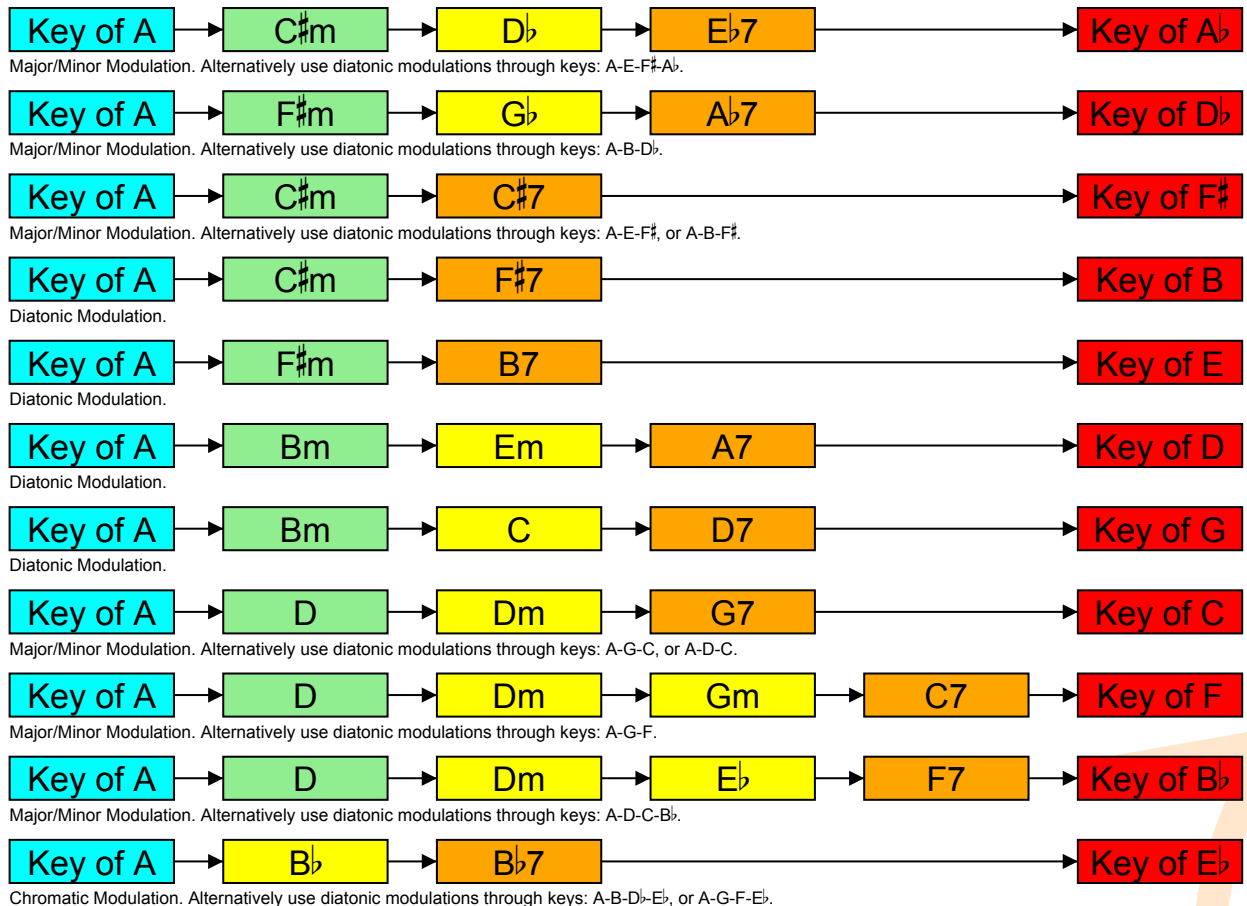

A

IMPORTANT CHORDS

m

M7

m7

7

USEFUL CHORDS

2

sus4

6

11

+5

M7+5

dim

dim7

MAJOR VARIATIONS

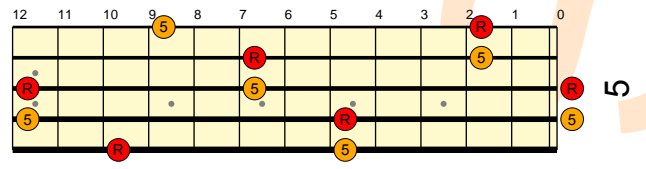
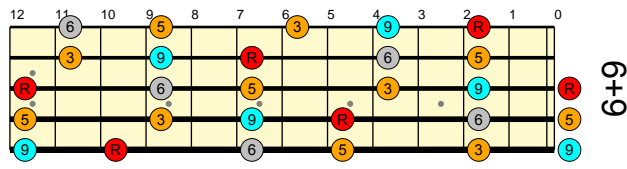

MINOR VARIATIONS

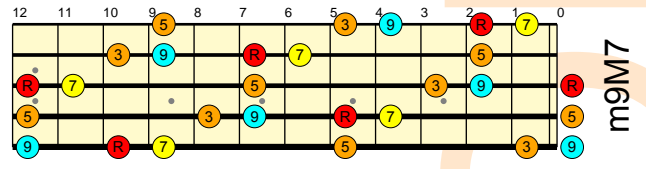
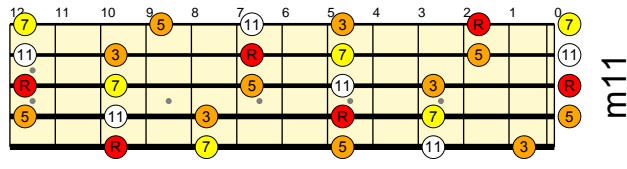
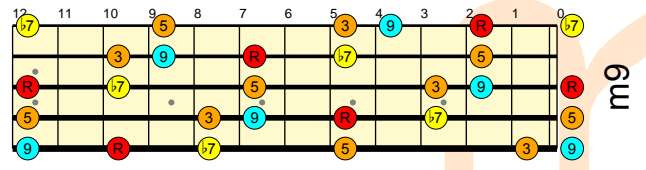
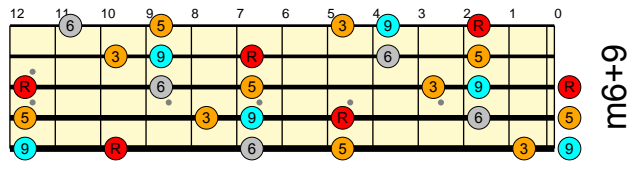
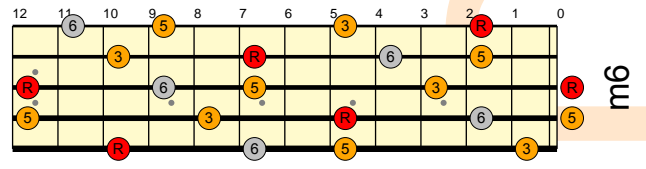
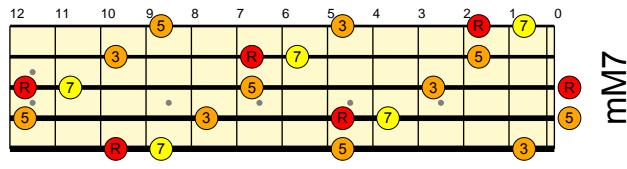

SEVENTH VARIATIONS

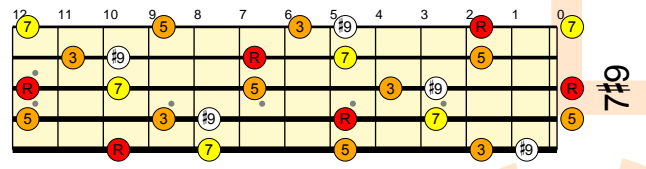
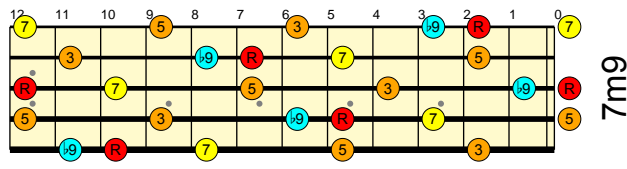
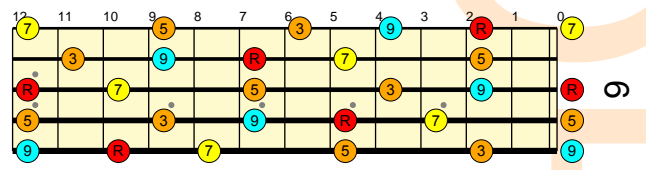
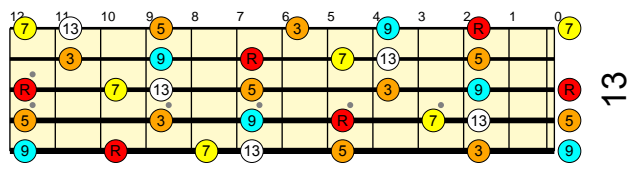

FOURTH VARIATIONS

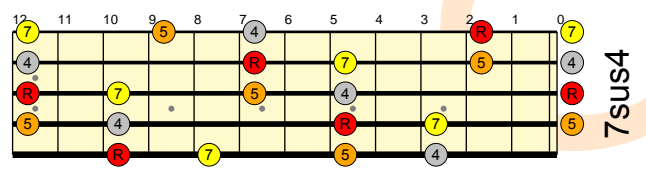
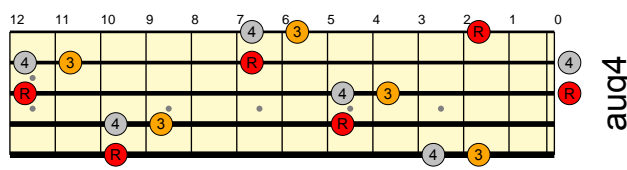

DIMINSHED / AUGMENTED

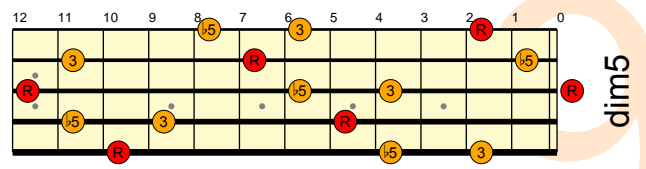
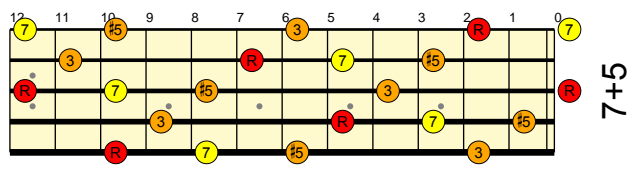
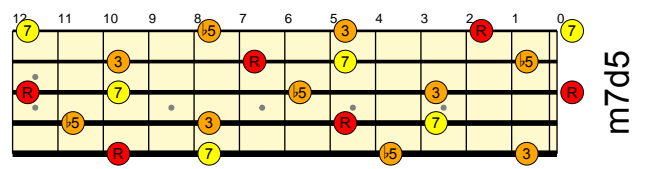
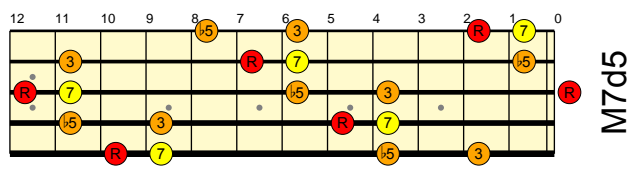

A

SCALES

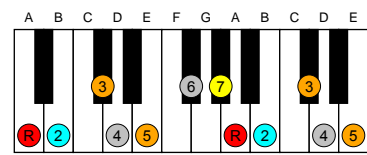
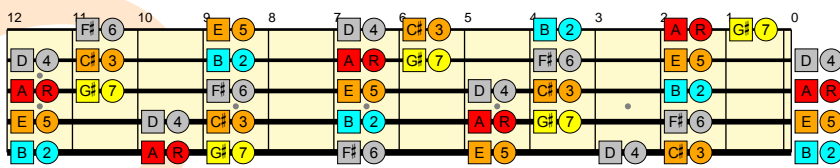

major

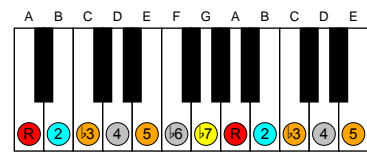
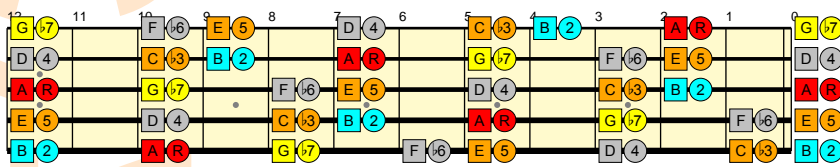

minor

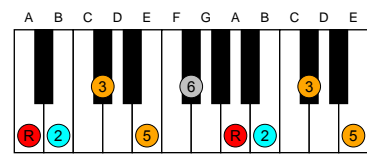
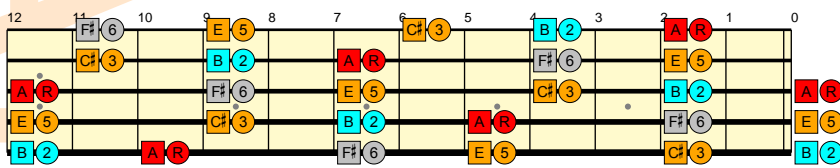

pentatonic

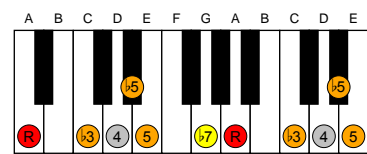
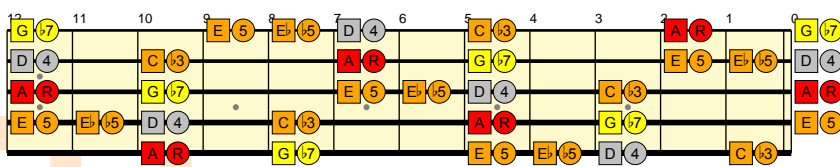

blues

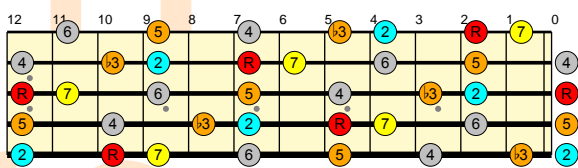

m. minor

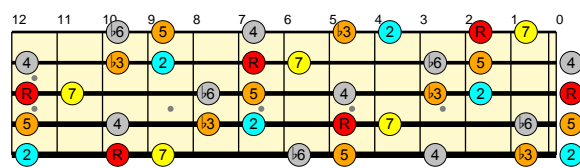

h. minor

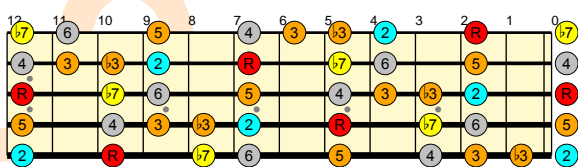

m bebop

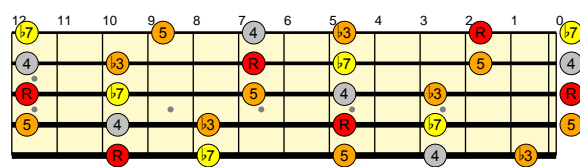

m pent.

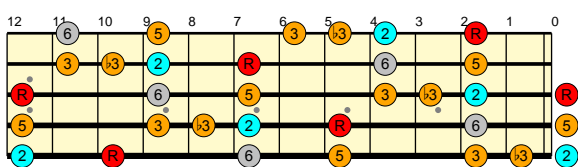

M blues

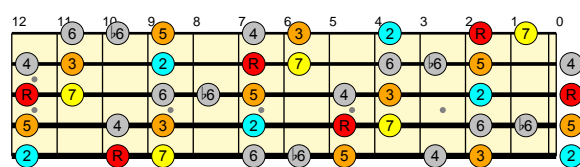

M bebop

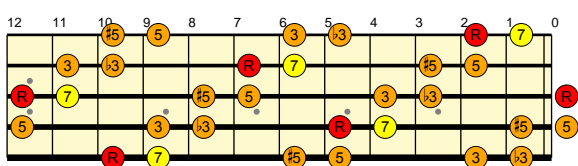

aug.

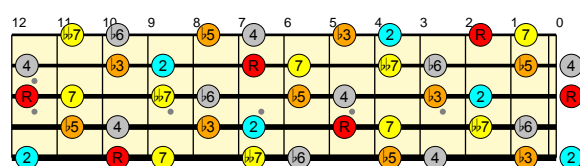

dim.

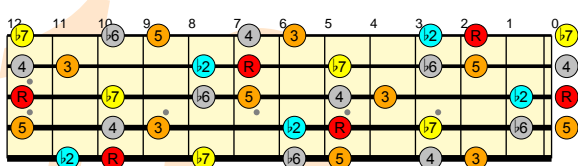

jewish

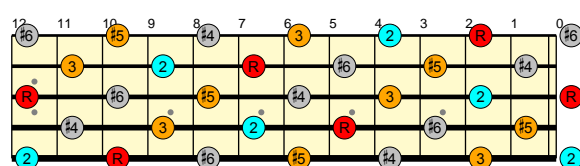

wh. tone

MAJOR MODE SCALES

		ionian
		dorian
		phrygian
		lydian
		mixolydian
		locrian

MINOR MODE SCALES

		dorian $\flat 2$
		lydian $\flat 6$
		lydian dom
		locrian $\sharp 2$
		altered
		lydian aug

SYNTHETIC / OBSCURE SCALES

		hirajoshi
		M neapolitan
		double h.
		in sen
		m neapolitan
		hungarian

SCALES OVER CHORDS

Look up the chord in the left column. Spots show which scales you can use to solo over the top.

	BASIC				BLUES		DIM/AUG		MAJOR MODE SCALES					MINOR MODE SCALES					
	major	minor	m. minor	h. minor	blues	M blues	dim.	aug.	dorian	phrygian	lydian	locrian	mixolydian	dorian $\flat 2$	lydian aug	lydian dom	mixolyd. $\flat 6$	locrian $\sharp 2$	altered
Major	●					●		●			●		●			●	●		
m		●	●	●	●	●		●	●	●				●					
M7	●							●			●								
m7		●			●				●	●				●					
7													●			●	●		
sus4	●	●	●	●	●				●	●			●	●			●		
2	●	●	●	●		●			●		●					●	●		
11													●				●		
6	●					●					●					●			
M7+5								●							●				
+5								●							●		●		●
dim7							●												
dim					●		●					●						●	●
5	●	●	●	●	●	●		●	●	●		●	●	●		●	●		
6+9	●					●					●					●			
m6			●			●			●					●					
mM7			●	●				●											
m9		●							●										
m6+9			●			●			●										
m11		●			●				●	●				●					
9													●			●	●		
13													●			●			
7sus4		●			●				●	●			●	●			●		
aug4	●												●				●		
m7d5					●							●						●	●
M7d5											●				●				
dim5											●				●	●			●
7+5																●			●